

CP7122 ZUME™ IN DL

Indoor – Luminous Globe with Downlight



VisaLighting.com/products/Zume-DL

Type: _____ Project: _____ Location: _____



DIMENSIONS ^{1,9}

OAH MUST BE SPECIFIED

OAH is the distance (in inches) from the bottom of the fixture to the ceiling plane.

DIA = Diameter OAH = Standard Overall Height WT=Weight

CP7122-	12	16	22
DIA	12" (305 mm)	16" (406 mm)	22" (559 mm)
MIN OAH	20" (508 mm)	24" (610 mm)	30" (762 mm)
STD OAH	72" (1829 mm)	72" (1829 mm)	72" (1829 mm)
MAX OAH	192" (4877 mm)	192" (4877 mm)	192" (4877 mm)
WT	12 lbs	13 lbs	16 lbs

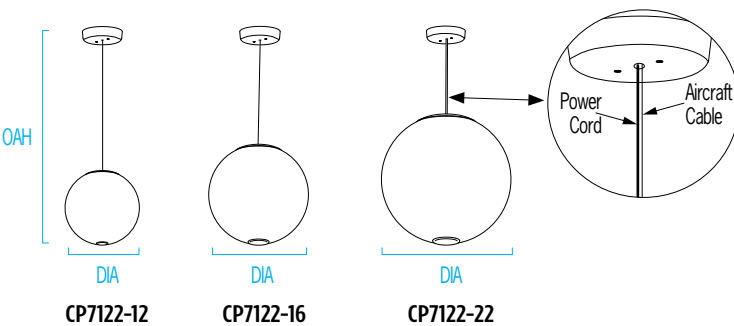

RELATIVE SCALE DRAWING

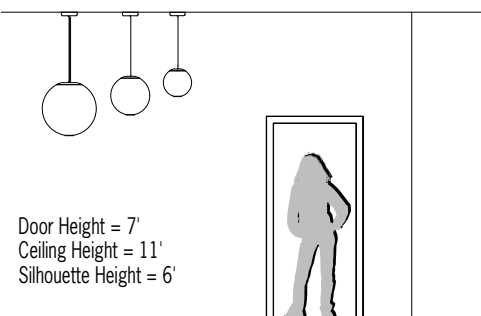

FEATURES

- BAA (Buy American Act) and BABA (Build American, Buy America) compliant
- Consistent luminance across all sizes
- Downlight, 0-10V dimmable (controls by others), with optional narrow, medium, or wide optical distribution
- Remote Driver (RMD) or Driver in Canopy (SDC) configurations available
- Remote Driver (RMD) includes round canopy 5-1/4" diameter and 1/2" deep
- Driver in canopy (SDC) includes round canopy 6-3/8" diameter and 1-1/2" deep
- Canopy mounts over 4x4 junction box (by others) with provided hardware and is painted white
- One piece gloss white acrylic globe for seamless appearance
- Suspended by 2-conductor white power cord and aircraft cable
- Non-VOC powder coat finishes or environmentally friendly low VOC metal alternative finishes
- ETL listed for damp locations. Not suited for exterior application

SPHERE PHOTOMETRICS

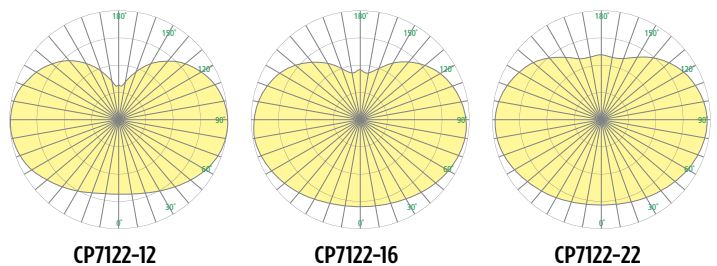

Compliant



ETL Listed



5 Year Warranty

CP7122 ZUME™ IN DL (cont.)

Indoor – Luminous Globe with Downlight



Fill in shaded boxes using information listed below

CP7122

- MVOLT

MODEL	DIAMETER ¹	BODYLIGHT ² SOURCE	DOWNLIGHT ³ SOURCE	DOWNLIGHT ⁴ OUTPUT	VOLTAGE MVOLT	DRIVER ⁵ RMD SDC	SOURCE ⁶ OPTION 90CRI	DOWNLIGHT ⁷ OPTIC MED NRW WIDE	CAP/CANOPY FINISH	OPTION ⁸ DCC	OAH ⁹
	12" 16" 22"	L30K L35K L40K	L30K L35K L40K	LOW MED HIGH			90CRI is standard		See last page for finish order codes		See page 1

BODYLIGHT SOURCE² (Select one)

Dimmable 0-10V to 1%, 90CRI, within 3-step MacAdam

Bodylight Source	Delivered Lumens		
	CP7122-12	CP7122-16	CP7122-22
L30K	2300	3600	6300
L35K	2400	3700	6500
L40K	2400	3800	6600
Power (Watts)	18	28	49

VOLTAGE

MVOLT	120-277V, 50/60 Hz
-------	--------------------

LUMEN MAINTENANCE RATING

Body Light L80 (reported)	>50,000 hrs
Downlight L70 (reported)	>55,000 hrs

DOWNLIGHT³ (Select one)

DOWNLIGHT SOURCE	CCT
L30K	3000K
L35K	3500K
L40K	4000K

DOWNLIGHT APERTURE & LIP

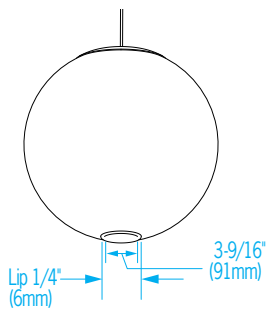

DOWNLIGHT OUTPUT⁴ (Select one)

Dimmable 0-10V to 1%, minimum 80CRI, within 3-step MacAdam

Option	Delivered Lumens		POWER (WATTS)
	L30K/L35K	L40K	
LOW	860	875	6
MED	1400	1425	10
HIGH	2000	2040	15

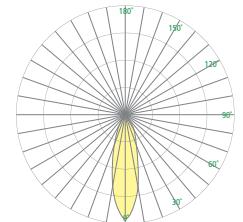

CP7122-NRW

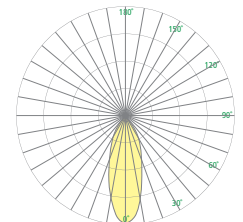

CP7122-MED

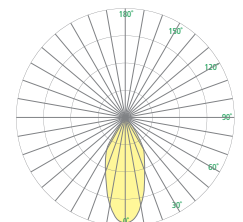

CP7122-WIDE

Options continued on Page 3

CP7122 ZUME™ IN DL (cont.)

Indoor – Luminous Globe with Downlight



DRIVER⁵ (Select one)

⚠ Availability may be interdependent with Voltage, Source or Other Options

SDC	Surface canopy with integral driver; canopy is painted white
RMD	Remote driver enclosure, has knockouts for conduit connection, may be recess mounted with insulation contact (type IC). Canopy is painted white.

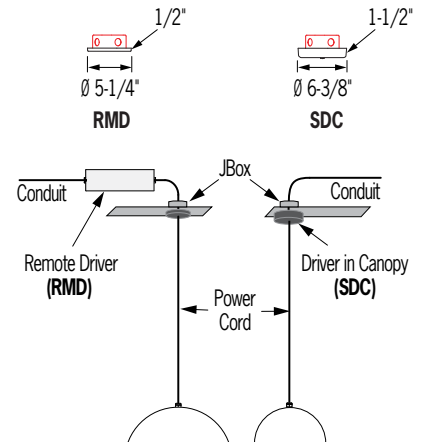

REMOTE DRIVER (RMD) INFORMATION

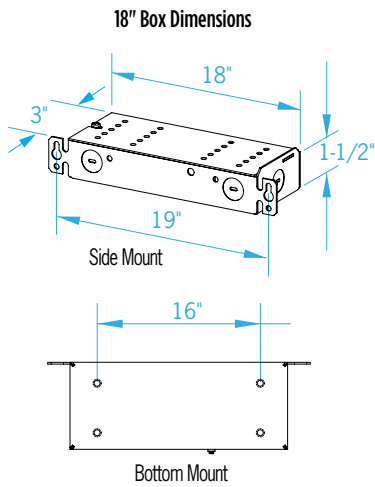

Model	Maximum Recommended Remote Wiring Distance from RMD to fixture canopy			
	12AWG	14AWG	16AWG	18AWG
CP7122-12	475	275	175	100
CP7122-16	475	275	175	100
CP7122-22	200	100	50	25

All distances in feet

Remote driver boxes have knockouts for conduit connections

OPTION⁸

⚠ Option availability may be interdependent with Other Options

DCC	Damp clear coat for metal finishes (required for 5 year warranty when used in damp locations)
------------	---

CP7122 ZUME™ IN DL (cont.)

Indoor – Luminous Globe with Downlight



ZUME PRODUCT FAMILY

Indoor	White LED		RGBW	
Zume In	<ul style="list-style-type: none"> • CP7120-8 • CP7120-12 • CP7120-16 	Cord Suspension	<ul style="list-style-type: none"> • CP7126-8 • CP7126-12 • CP7126-16 	Stem
	<ul style="list-style-type: none"> • CP7120-22 	Cord & Cable Suspension	<ul style="list-style-type: none"> • CP7126-22 	
Zume DL	<ul style="list-style-type: none"> • CP7122-12 • CP7122-16 • CP7122-22 	Cord & Cable Suspension	<ul style="list-style-type: none"> • CP7128-8 • CP7128-12 • CP7128-16 • CP7128-22 	Stem
Outdoor				
Zume Out	Cord & Cable Suspension	<ul style="list-style-type: none"> • OP2120-ShortCap – 12” • OP2130-ShortCap – 16” • OP2140-ShortCap – 20” 	<ul style="list-style-type: none"> • OP2120-SolidCap – 12” • OP2130-SolidCap – 16” • OP2140-SolidCap – 20” 	<ul style="list-style-type: none"> • OP2120-SlottedCap – 12” • OP2130-SlottedCap – 16” • OP2140-SlottedCap – 20”
	Catenary Suspension	<ul style="list-style-type: none"> • OP2122-ShortCap – 12” • OP2132-ShortCap – 16” • OP2142-ShortCap – 20” 	<ul style="list-style-type: none"> • OP2122-SolidCap – 12” • OP2132-SolidCap – 16” • OP2142-SolidCap – 20” 	<ul style="list-style-type: none"> • OP2122-SlottedCap – 12” • OP2132-SlottedCap – 16” • OP2142-SlottedCap – 20”
	Stem Suspension	<ul style="list-style-type: none"> • OP2124-ShortCap – 12” • OP2134-ShortCap – 16” • OP2144-ShortCap – 20” 	<ul style="list-style-type: none"> • OP2124-SolidCap – 12” • OP2134-SolidCap – 16” • OP2144-SolidCap – 20” 	<ul style="list-style-type: none"> • OP2124-SlottedCap – 12” • OP2134-SlottedCap – 16” • OP2144-SlottedCap – 20”

See [Visalighting.com/families/zume](https://visalighting.com/families/zume) for more information

SUGGESTED VARIATION

- Recommend custom cover plate over downlight opening for CCT consistency in spaces requiring combinations of globes with and without downlight

CP7122 ZUME™ IN DL (cont.)

Indoor – Luminous Globe with Downlight



FINISHES

Specify color code when ordering. For accurate color matching, individual paint and finish samples are [available upon request](#). For more information about our finishes visit visalighting.com/finishes

Powder Coat Paint Finishes (Standard)

AGGY Agate Grey	ALGN Alpine Green	BMAT Bronze Matte	BRNZ Bronze	BSIL Blade Silver	CVBL Cove Blue	DEOR Deoro Gold
GLWT Glacier White	GSIL Graphite Silver	HRGR Harbor Grey	JTBK Jet Black	OCBL Ocean Blue	SHGR Shoreline Grey	SBGN Sagebrush Green
SLGR Slate Grey	SSTP Sierra Taupe	TRCN Terracotta Canyon	TRWT Traffic White	VBLK Velvet Black	VNRD Vineyard Red	

Alternative Metal Finishes (Premium)

BBA Brushed Brass Alternative	BCA Brushed Chrome Alternative	BUA Brushed Copper Alternative	BZA Brushed Bronze Alternative
OBA Oil-Rubbed Bronze Alternative	PRA Pewter Alternative	RBA Rustic Brass Alternative	SNA Satin Nickel Alternative

Metal Finish (Premium)

BA Brushed Aluminum

